

TRAILBOSS

Tow bar Fitting Instructions To Suit Nissan J10 Dualis 10-07-on Part Number DS97L

Rating (Auto) 1200 kg (Manual) 1400Kg Max Static Ball Load 120Kg

WARNING:

1. Do not, drill, cut, weld or otherwise modify the tow bar.
2. If you are using electric welding on a motor vehicle, **always** check that the vehicle is not equipped with electronic engine or instrument management equipment. Failure to do so could **destroy** any onboard computers. If in doubt, check with the vehicle's manufacturer.

General:

1. Ensure all hardware items have been included refer to assembly diagram.
2. It is recommended that the instructions are read through and completely understood before making any attempt to fit this product.
3. Be wary of any changes to vehicle designs or other accessories that may conflict with the installation of this product.
4. Before drilling ensure that the area is clear of fuel, electrical & other components.
5. All holes drilled into the body panels shall have all burrs & swarf removed then coated with a suitable rust preventative paint.
6. The high tensile fasteners supplied with this product were used to achieve the specified rating. If replacement is required ensure that fasteners of the same rating & quality are used. Contact an authorized **Trailboss** dealer if further information is required.
7. Ensure that all hardware is fastened to torque list below check fasteners on regular basis.
8. Tow bar load rating sticker provided with this product shall be conspicuously located on inside rear end of the driver's door. **(See diagram below).**
9. Trailboss recommends that you check your tow ball to ensure that it complies with the Australian standards **AS 4177.2**.
10. **PLEASE NOTE:** It is advised to remove your lug or tbn when not actually towing so as to produce a clear view of the vehicles registration plate if obscured, and to also provide maximum available departure angle

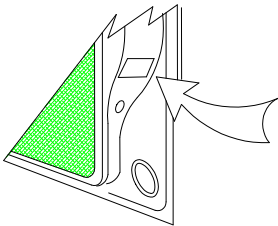

Place load rating sticker
inside driver's door here

FOR TOWING PURPOSES ONLY

For towing capacity details please refer to vehicle owner's manual or to the manufacturer. Overloading can void your warranties.

RECOMMENDED ASSEMBLY TORQUE LISTING

Diameter Grade 8.8 Bolt

M6	9.5 Nm
M8	21.7 Nm
M10	43.4 Nm
M12	77.3 Nm
M16	189.8 Nm

Tow bar Maintenance and Care.

Trailboss recommends that bolt torque's, as listed below, are routinely and regularly inspected and checked for correct tension. Replace any worn or defective parts.

We recommended to remove Tow Ball Mounts (TBM's, tongues or lugs) when not being used for any considerable length of time.

So as to avoid injury, when not towing it is suggested that the tongue, Pull Pin and R-clip are removed then stored in a safe, clean and dry place, away from excessive moisture.

Hitch Pull Pins and spring "R" clips are regularly checked for proper installation. Replace any worn or defective parts.

Tow bar Fitting Instructions To Suit Nissan J10 Dualis 10-07-on Part Number DS97L

Rating (Auto) 1200 kg (Manual) 1400Kg Max Static Ball Load 120Kg

11. Inside rear luggage compartment

- Lift up rear luggage compartment lid to expose foam inserts prop lid to gain better access to remove foam compartments.
- Remove foam insert from driver's side of vehicle see fig1.
- Remove spare wheel jack & foam insert from passenger side of the vehicle see fig 2.

Foam insert on the drivers side of the vehicle.



Fig 1

Spare wheel jack & foam insert on passenger side of the vehicle.



Fig 2

12. Inside rear luggage compartment

- Remove rear plastic trim via 2x plastic trim plugs from inside rear tailgate cavity then pull trim upwards to disengage some force may be required see fig 3.

Remove rear trim so that there is better access to remove the side felt trims either side of the vehicle.



Fig 3

Felt trim disengage to gain better access to floor pan via removing the trim plug one each side.

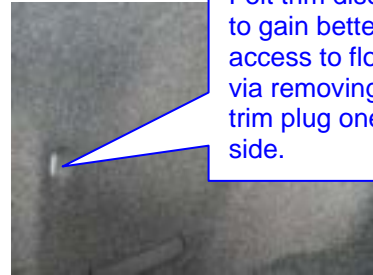

Fig 4

13. Inside rear luggage compartment

- Remove rear plastic trim via 2x plastic trim plugs from inside rear tailgate cavity then pull trim upwards to disengage some force may be required see fig 3.
- Partially remove the felt trim each side of the vehicle to expose the floor pan to gain better access to drill holes in chassis see fig 4.
- Lower the rear muffler via the 3 x rubber hangers to gain better access to the under side chassis rails crc can be used to aid removal of the rubbers.

Drill 12mm through this hole from underneath the vehicle into the tailgate cavity.

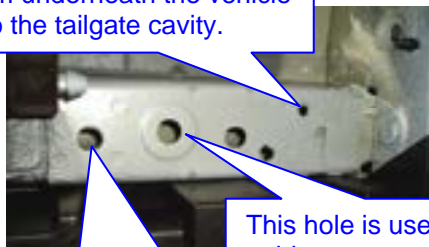

Fig 5
Pass side

Using this hole as a guide centre punch then drill 12mm through into tailgate cavity

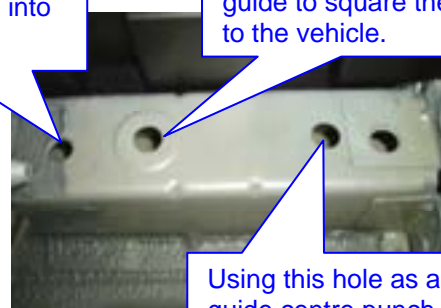

Fig 6
Dr side

This hole is used as guide to square the bar to the vehicle.

Using this hole as a guide centre punch then drill 12mm through into tailgate cavity

This hole is used as guide to square the bar to the vehicle.

Using this hole as a guide centre punch then drill 12mm through into tailgate cavity

Important ensure that the wires shown in figs 7 & 8 are out of the way before drilling or damage could occur.

Tow bar Fitting Instructions To Suit Nissan J10 Dualis 10-07-on Part Number DS97L

Rating (Auto) 1200 kg (Manual) 1400Kg Max Static Ball Load 120Kg

14. Drilling of chassis rails

- Drill through 12 mm as shown in figures 5 & 6 into tailgate cavity ensure that all sharp edges & swarf are removed and raw edges are coated with suitable rust preventive paint.

Then fit the crush tubes as shown.

Enlarge the 12mm drilled holes to 22mm on the top face only to except crush tubes.

Enlarge the 12mm drilled holes to 22mm on the top face only to except crush tubes.

Fig 7

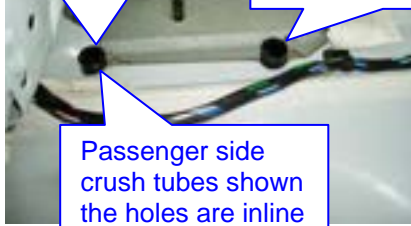

Passenger side crush tubes shown the holes are in line

Fig 8

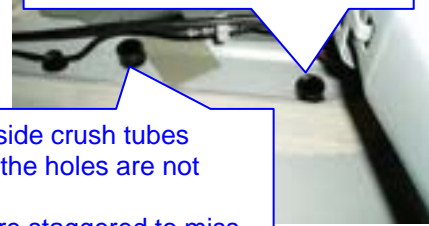

Driver side crush tubes shown the holes are not in line They are staggered to miss the towing eyelet.

15. Fitment of boot plates & coach bolts

- Fit coach bolts provided to boot plates then align coach bolts with crush tubes inside the chassis rails so that coach bolts go all the way through the chassis.
- Note that the passenger side boot plate will align square but the driver's side boot plate will rotate to one side.

Passenger side boot plates ensure that wiring is out of the way of the plate so not to damage wiring.

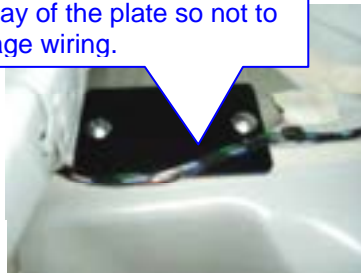

Fig 9

Note that the plate is rotated to one side



Driver side boot plates ensure that wiring is out of the way of the plate so not to damage wiring.

Fig 10

16. Cut out section of bumper bar skin via

- Place masking tape over the outside of the bumper bar skin so not to damage outer surface while cutting.
- Mark out as shown in the bumper cut detail fig 11.
- Then cut with suitable saw or similar device ensure that all edges are filed and free from swarf or burred edges.

Establish centre line of the bumper bar skin then mark out 50mm each side of centre line as shown.

Measure up 55mm from bottom edge of bumper bar skin then mark with suitable marker.

55mm

Fig 11

100mm

Area of bumper bar skin to be removed

Cut with suitable saw or similar device

Fig 12

Loose plate spring washer & M12 nut driver's side shown on rear most coach bolt.



Forward most coach bolt flat & spring washer with M12 nut.

Tow bar Fitting Instructions To Suit Nissan J10 Dualis 10-07-on Part Number DS97L

Rating (Auto) 1200 kg (Manual) 1400Kg Max Static Ball Load 120Kg

17. Fitment of tow bar to vehicle via

- a. **Caution** two person lift required offer tow bar to the vehicle sub frame so that the coach bolts hanging down through the chassis align with the slots in the side arms of the tow bar see fig 12.
- b. Fit loose plates spring washers & M12 nuts to rear most coach bolt towards the rear of the vehicle loosely.
- c. Fit M12 flat & spring washers with M12 nuts to the forward most coach bolt loosely.
- d. Then align the bar to the centre of the vehicle via the two holes in the side plates refer to figures 5 & 6.
- e. Once bar is square to the vehicle fasten to the torque listing.
- f. Refit the rear muffler to the rubber hangers.
- g. Refit the felt trim and plastic rear trim with foam compartments in the reverse of steps 13b through to 11a.
- h. Fit the tow bar tongue to the tow bar with the 16mm bolts & washers supplied see assembly detail for correct component orientation ensure that all fasteners are tightened to the torque listing.

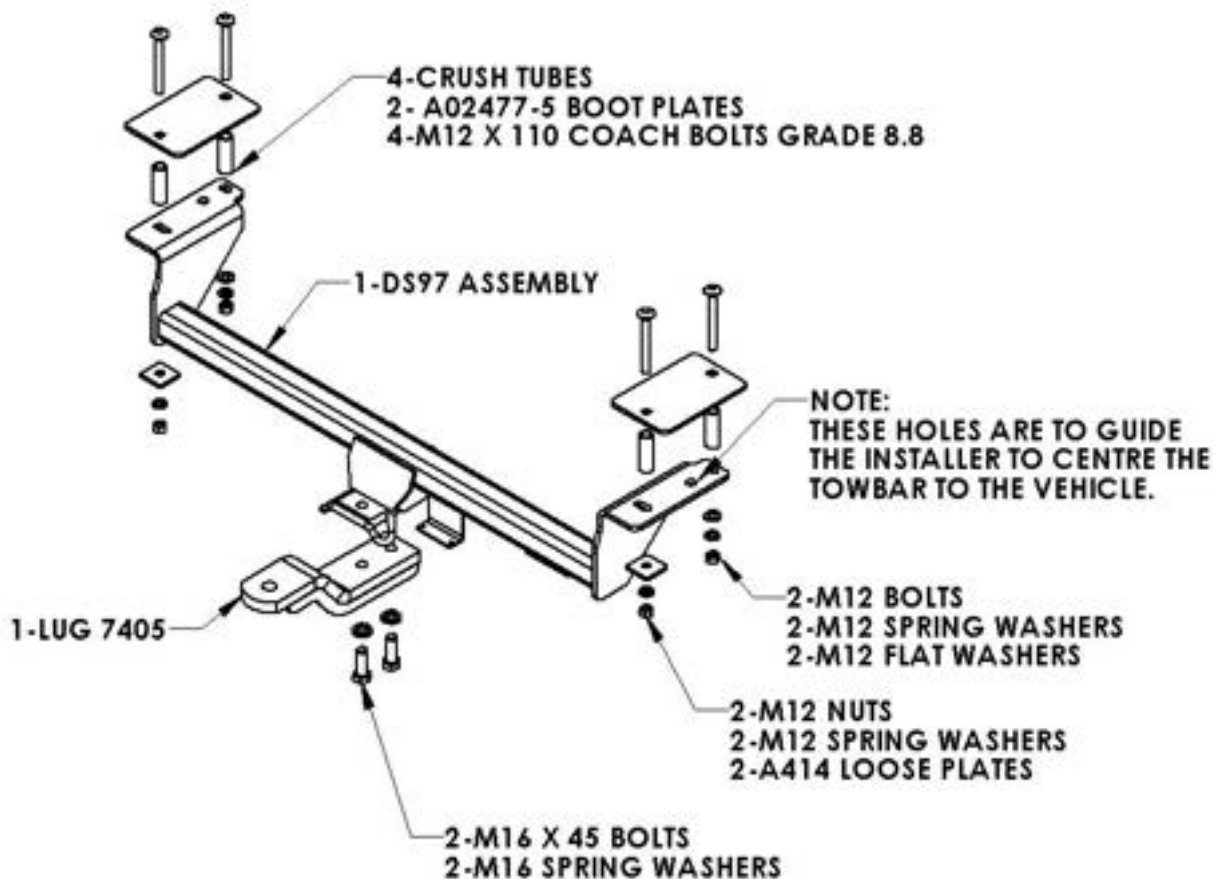



Tow bar Fitting Instructions
To Suit Nissan J10 Dualis 10-07-on
Part Number DS97L
Rating (Auto) 1200 kg (Manual) 1400Kg Max Static Ball Load 120Kg

Wiring Loom Installation Instructions

Nissan J10 Dualis
(October '07 Onwards)
Part No: 100062-WL

Tail Harness Length Required: 1200mm
RPA Override Switch Part No: 04848 (If Fitted)

Wiring Loom Installation Time: Approx 30 Mins



Tow bar Fitting Instructions
To Suit Nissan J10 Dualis 10-07-on
Part Number DS97L

Rating (Auto) 1200 kg (Manual) 1400Kg Max Static Ball Load 120Kg

1. In the luggage compartment, remove the parcel shelf.
2. Remove the floor carpet cover.
3. Fold the rear seats forward.
4. Remove the LHS & RHS tool trays.
5. Remove the rear trim by first removing the two clips.
6. Remove the LHS side trim by first removing the two clips.
7. Repeat for the RHS.
8. Drill a Ø31mm hole in the vehicle sheet metal on the LHS of the luggage compartment, above the existing vehicle grommet.
9. File any rough or sharp edges and spray on rust inhibitor.
10. From outside the vehicle, remove the LHS tail light by first removing the two bolts.
11. Disconnect the LHS tail light 4-way connector from the LHS tail light assembly.
12. Remove the LHS tail light assembly and store in a safe place.
13. Feed the LHS tail light 4-way connector in through the LHS tail light cavity.
14. Repeat Steps for the RHS.
15. In the luggage compartment, locate the LHS tail light 4-way connector.
16. Patch in the Trailer Harness (P/No: 100062-WL) mating 4-way connector.
17. Route the remaining Trailer Harness 4-way connector out through the LHS tail light cavity and connect it to the LHS tail light assembly.
18. Connect the Trailer Harness ground ring terminal to the LHS vehicle grounding point.
19. Route the Trailer Harness along the rear of the luggage compartment and towards the RHS tail light connectors.
20. Locate the RHS tail light 4-way connector.
21. Patch in the Trailer Harness mating 4-way connector.
22. Route the remaining Trailer Harness 4-way connector out through the RHS tail light cavity and connect it to the RHS tail light assembly.



Tow bar Fitting Instructions
To Suit Nissan J10 Dualis 10-07-on
Part Number DS97L

Rating (Auto) 1200 kg (Manual) 1400Kg Max Static Ball Load 120Kg

23. Mount the Trailer Socket to the towbar mounting bracket using M4 fasteners (not supplied).
24. Route the Tail Harness (tail length 1200mm) across the towbar towards the LHS of the vehicle and up through the previously drilled out hole.
25. Ensure the Tail Harness grommet is seated correctly and secure in place using a cable tie (not supplied).
26. Connect the tail harness 8-way connector to the trailer harness mating 8-way connector.
27. Test the Trailer Harness function using a Light Board or multi-meter.
28. Secure all Harnesses using cables ties (not supplied).
29. Re-fit all removed parts and secure all fasteners, ensuring there are no squeaks or rattles.
30. Place the instructions in the glove box after fitment.